

NOVO HIGH VOLTAGE

NIC CAPACITOR AND EQUIPMENT

Guide to Product Selection and Application



NOVO
Electric technology UK Ltd

www.ests.uk

Table of content

Description	Page
Table of contents	2
Specifications for High Voltage Capacitors and Equipment	3
Types of Capacitor Protection Designs	4
Individual High Voltage Capacitors	6
For Fuseless & Externally Fused Applications	7
Individual High Voltage Fuseless 3-Phase Capacitors	8
High Voltage Capacitor & Equipment Fuse & Accessories	9
Capacitors & Equipment for High Voltage Surge	10
High Voltage Surge Capacitors & Equipment	11
Protective Capacitor- Altitude De-Rating	12
High Voltage Surge Capacitors & Equipment	13
Distribution Pole Top Equipment	15
Shunt Capacitor Bank Equipment	17
Metal Enclosed Capacitor Bank Equipment	18
Series Capacitor Compensation Systems	18



Specifications for High Voltage Capacitors and Equipment

The reasons that require correction.

Rapid growth of inductive electric loads on utility systems has impacted the efficient operation of AC electrical transmission and distribution systems by increasing the need for reactive power (kilovars) that are required to be supplied with active power (kilowatts).

Influencing the Power Triangle:

- ⚡ One wave form (voltage or current) leads the other
- ⚡ Phase angle not equal to 0 degrees
- ⚡ Power factor less than unity

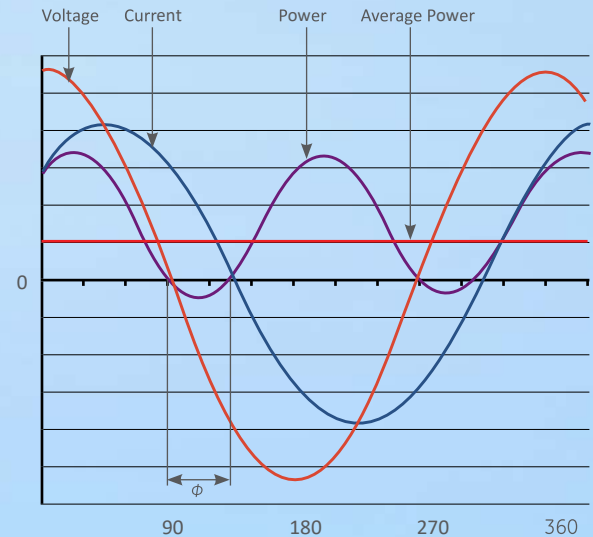

Examples include transformers, motors, and fluorescent lights.

In simple AC circuit both current and voltage are sinusoidal. At every insistence the product of voltage and current is positive, indicating the direction of energy flow does not reverse, only real power is transferred. If the load on the circuit is Reactive, the voltage and current are out of phase. The product of voltage and current is at times negative, causing the energy flow to reverse.



Types of Capacitor Protection Designs

⚡ Application



>34.5kv L-L, open rack shunt

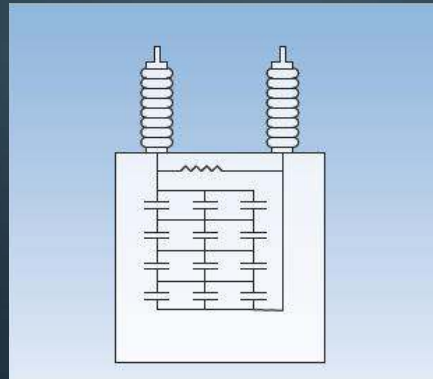

FUSELESS DESIGN

- Lowest losses, typically < 0.12 watts/kVAR
- Highest reliability: A lower internal element voltage stress rise for the same number of internal failures in comparison to an internally fused option.
- A higher unbalanced current for the same internal element voltage stress.
- Fault tolerance with continued operation even with failed rolls.



All voltage levels, open rack or metal enclosed

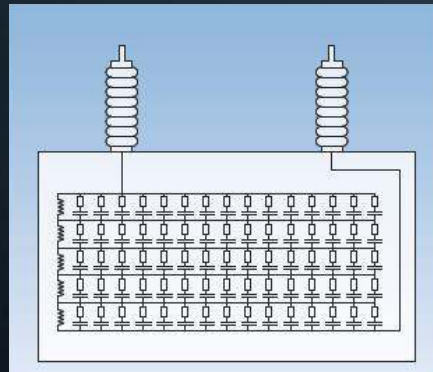

INTERNALLY FUSED DESIGN

- Losses, typically > 0.15 watts/kVAR
- One fuse per internal roll. Each roll is protected by an internal fuse element.
- The fuse allows the roll to fail as an open circuit
- There are multiple rolls in parallel. This places a very small incremental stress on adjacent rolls when a fuse operates. This helps prevent a cascading failure within an individual capacitor can.



All voltage levels, pole top, open rack and metal enclosed

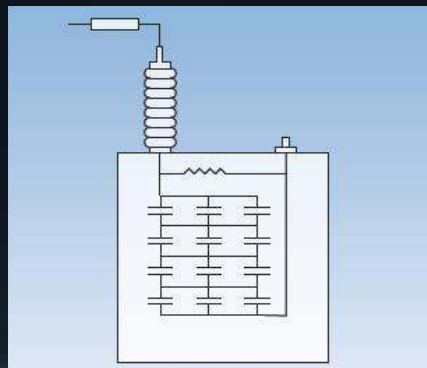

EXTERNALLY FUSED DESIGN

- One fuse per capacitor unit. Fewer connections equals fewer points of failure.
- Facilitates easy identification of a failed capacitor as the blown fuse is obvious.
- Once the standard, now limited to specialty applications.

Types of Capacitor Protection Designs

⚡ Application

KVAR Sizes

- Single Phase Units from 25 to 1000 KVAR
- 3 Phase Individual units of 300 & 400 KVAR

Voltage Ranges

2,400 to 25,000 Volt

Low Stress and Heavy Duty Designs

For Increased durability and tolerance of harmonics and transients.



NOVO Design Benefits Resulting in Higher Quality

- ⚡ Fuseless and Externally Fused Designs meet or exceed IEC 60871 and IEEE 18 standards.
- ⚡ State of the art Winding Machines in clean room facility
- ⚡ Precision capacitor pack designs assures accurate and tight capacitance control
- ⚡ Ultrasonic Welding provides for a consistent, high quality process for connecting capacitor elements. This reduces risks of mechanical defect and failure from other types of connections
- Folded foil design technology provides for a consistent smooth foil edge, reducing the build-up of electrical stress on the foil head, tail and edge
- Automated case welding for better and consistent welds, resulting in
- ⚡ higher quality and fewer case leaks

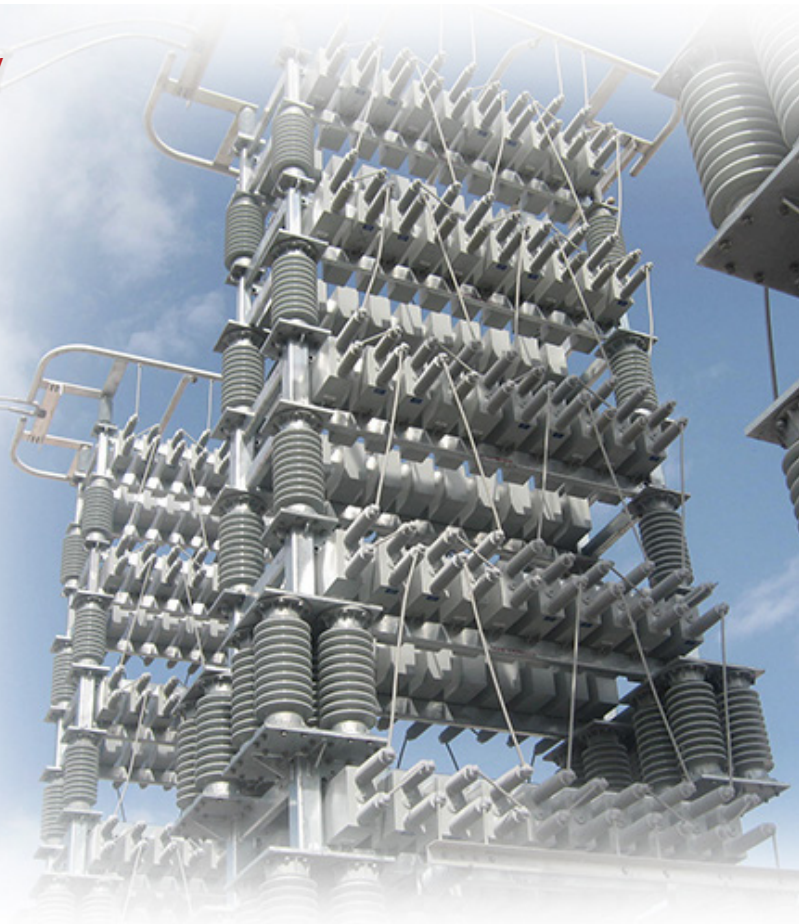

Individual High Voltage Capacitors

⚡ Single Phase High Voltage Capacitors- Standard Ratings

Voltage	BIL	50 kVAR		100 kVAR		150 kVAR		200 kVAR	
		1 Bushing	2 Bushing	1 Bushing	2 Bushing	1 Bushing	2 Bushing	1 Bushing	2 Bushing
2400	95	51L221WC62	51L201WC62	54L221WC62	54L201WC62	54L521WC62	54L501WC62	58L121WC62	58L101WC62
2770	95	51L222WC59	51L202WC59	54L222WC60	54L202WC60	54L522WC60	54L502WC60	58L122WC60	58L102WC60
4160	95	51L223WC28	51L203WC28	54L223WC60	54L203WC60	54L523WC60	54L503WC60	58L123WC60	58L103WC60
4800	95	51L224WC60	51L204WC60	54L224WC62	54L204WC62	54L524WC62	54L504WC62	58L124WC62	58L104WC62
6640	95	51L225WC60	51L205WC60	54L225WC60	54L205WC60	54L525WC60	54L505WC60	58L125WC60	58L105WC60
7200	95	51L226WC60	51L206WC60	54L226WC60	54L206WC60	54L526WC60	54L506WC60	58L126WC60	58L106WC60
7620	95	51L227WC60	51L207WC60	54L227WC60	54L207WC60	54L527WC60	54L507WC60	58L127WC60	58L107WC60
7960	95	51L228WC60	51L208WC60	54L228WC60	54L208WC60	54L528WC60	54L508WC60	58L128WC60	58L108WC60
8320	95	51L235WC60	51L215WC60	54L235WC60	54L215WC60	54L535WC60	54L515WC60	58L129WC60	58L109WC60
9960	95	51L234WC60	51L214WC60	54L234WC60	54L214WC60	54L534WC60	54L514WC60	58L130WC60	58L110WC60
12470	95	51L229WC60	51L209WC60	54L229WC60	54L209WC60	54L529WC60	54L509WC60	58L131WC60	58L111WC60
13280	95	51L230WC60	51L210WC60	54L230WC60	54L210WC60	54L530WC60	54L510WC60	58L132WC60	58L112WC60
13800	95	51L231WC60	51L211WC60	54L231WC60	54L211WC60	54L531WC60	54L511WC60	58L133WC60	58L113WC60
14400	95	51L232WC60	51L212WC60	54L232WC60	54L212WC60	54L532WC60	54L512WC60	58L134WC60	58L114WC60
19920	150	51L255WC62	-	54L255WC62	-	54L555WC60	-	58L155WC60	-
21600	150	51L256WC62	-	54L256WC62	-	54L556WC60	-	58L156WC60	-

Single Phase High Voltage Capacitors- Standard Ratings ¹

Voltage	BIL	300 kVAR		400 kVAR		500 kVAR		600 kVAR	
		1 Bushing	2 Bushing	1 Bushing	2 Bushing	1 Bushing	2 Bushing	1 Bushing	2 Bushing
2400	95	NA	NA	NA	NA	NA	NA	NA	NA
2770	95	NA	NA	NA	NA	NA	NA	NA	NA
4160	95	59L123WC60	59L103WC60	98L123WC60	98L103WC60	NA	NA	NA	NA
4800	95	59L124WC62	59L104WC62	98L124WC63	98L104WC63	NA	NA	NA	NA
6640	95	59L125WC60	59L105WC60	98L125WC60	98L105WC60	98L525WC60	98L505WC60	98L585WC60	98L565WC60
7200	95	59L126WC62	59L106WC62	98L126WC63	98L106WC63	98L526WC62	98L506WC62	98L586WC60	98L566WC60
7620	95	59L127WC60	59L107WC60	98L127WC60	98L107WC60	98L527WC60	98L507WC60	98L587WC60	98L567WC60
7960	95	59L128WC60	59L108WC60	98L128WC60	98L108WC60	98L528WC60	98L508WC60	98L588WC60	98L568WC60
8320	95	59L129WC60	59L109WC60	98L129WC60	98L109WC60	98L529WC60	98L509WC60	98L589WC60	98L569WC60
9960	95	59L130WC60	59L110WC60	98L130WC60	98L110WC60	98L530WC60	98L510WC60	98L590WC60	98L570WC60
12470	95	59L131WC60	59L111WC60	98L131WC60	98L111WC60	98L531WC60	98L511WC60	98L591WC60	98L571WC60
13280	95	59L132WC60	59L112WC60	98L132WC60	98L112WC60	98L532WC60	98L512WC60	98L592WC62	98L572WC62
13800	95	59L133WC60	59L113WC60	98L133WC60	98L113WC60	98L533WC60	98L513WC60	98L593WC62	98L573WC62
14400	95	59L134WC62	59L114WC62	98L134WC62	98L114WC62	98L534WC62	98L514WC62	98L594WC62	98L574WC62
19920	150	59L155WC60	-	98L155WC62	-	98L555WC61	-	98L595WC61	-
21600	150	59L156WC60	-	98L156WC62	-	98L556WC61	-	98L596WC60	-

¹ Larger kVAR units, extra creep options and other voltages are available. Consult factory for product numbers and pricing.

For Fuseless & Externally Fused Applications

Single Phase High Voltage Capacitors- Heavy Duty Ratings

Heavy Duty all film dielectric capacitors are designed, manufactured and tested to meet the requirements of all applicable IEEE and IEC standards. In addition they are designed to exceed the requirements of these standards in terms of continuous (rms) and peak overvoltage withstand capabilities. They are rated for 125% continuous (rms) overvoltage capability and 135% peak overvoltage capability. These capacitors are suitable for industrial power systems that have higher voltages or harmonic loads.

Heavy Duty Ratings- 125% Continuous Overvoltage Capability Product Numbers

Voltage	BIL	50 kVAR		100 kVAR		150 kVAR		200 kVAR	
		1 Bushing	2 Bushing	1 Bushing	2 Bushing	1 Bushing	2 Bushing	1 Bushing	2 Bushing
2400	95	51L221WC10	51L201WC10	54L221WC10	54L201WC10	54L521WC10	54L501WC10	58L121WC10	58L101WC10
2770	95	51L222WC10	51L202WC10	54L222WC10	54L202WC10	54L522WC10	54L502WC10	58L122WC10	58L102WC10
4160	95	51L223WC10	51L203WC10	54L223WC10	54L203WC10	54L523WC10	54L503WC10	58L123WC10	58L103WC10
4800	95	51L224WC10	51L204WC10	54L224WC10	54L204WC10	54L524WC10	54L504WC10	58L124WC10	58L104WC10
6640	95	51L225WC10	51L205WC10	54L225WC10	54L205WC10	54L525WC10	54L505WC10	58L125WC10	58L105WC10
7200	95	51L226WC10	51L206WC10	54L226WC10	54L206WC10	54L526WC10	54L506WC10	58L126WC10	58L106WC10
7620	95	51L227WC10	51L207WC10	54L227WC10	54L207WC10	54L527WC10	54L507WC10	58L127WC10	58L107WC10
7960	95	51L228WC10	51L208WC10	54L228WC10	54L208WC10	54L528WC10	54L508WC10	58L128WC10	58L108WC10
8320	95	51L235WC10	51L215WC10	54L235WC10	54L215WC10	54L535WC10	54L515WC10	58L129WC10	58L109WC10
9960	95	51L234WC10	51L214WC10	54L234WC10	54L214WC10	54L534WC10	54L514WC10	58L130WC10	58L110WC10
12470	95	51L229WC10	51L209WC10	54L229WC10	54L209WC10	54L529WC10	54L509WC10	58L131WC10	58L111WC10
13280	95	51L230WC10	51L210WC10	54L230WC10	54L210WC10	54L530WC10	54L510WC10	58L132WC10	58L112WC10
13800	95	51L231WC10	51L211WC10	54L231WC10	54L211WC10	54L531WC10	54L511WC10	58L133WC10	58L113WC10
14400	95	51L232WC10	51L212WC10	54L232WC10	54L212WC10	54L532WC10	54L512WC10	58L134WC10	58L114WC10
19920	150	51L255WC10	-	54L255WC10	-	54L555WC10	-	58L155WC10	-
21600	150	51L256WC10	-	54L256WC10	-	54L556WC10	-	58L156WC10	-

Voltage	BIL	300 kVAR		400 kVAR		500 kVAR	
		1 Bushing	2 Bushing	1 Bushing	2 Bushing	1 Bushing	2 Bushing
2400	95	NA	NA	NA	NA	NA	NA
2770	95	NA	NA	NA	NA	NA	NA
4160	95	59L123WC10	59L103WC10	98L123WC10	98L103WC10	NA	NA
4800	95	59L124WC10	59L104WC10	98L124WC10	98L104WC10	NA	NA
6640	95	59L125WC10	59L105WC10	98L125WC10	98L105WC10	98L525WC10	98L505WC10
7200	95	59L126WC10	59L106WC10	98L126WC10	98L106WC10	98L526WC10	98L506WC10
7620	95	59L127WC10	59L107WC10	98L127WC10	98L107WC10	98L527WC10	98L507WC10
7960	95	59L128WC10	59L108WC10	98L128WC10	98L108WC10	98L528WC10	98L508WC10
8320	95	59L129WC10	59L109WC10	98L129WC10	98L109WC10	98L529WC10	98L509WC10
9960	95	59L130WC10	59L110WC10	98L130WC10	98L110WC10	98L530WC10	98L510WC10
12470	95	59L131WC10	59L111WC10	98L131WC10	98L111WC10	98L531WC10	98L511WC10
13280	95	59L132WC10	59L112WC10	98L132WC10	98L112WC10	98L532WC10	98L512WC10
13800	95	59L133WC10	59L113WC10	98L133WC10	98L113WC10	98L533WC10	98L513WC10
14400	95	59L134WC10	59L114WC10	98L134WC10	98L114WC10	98L534WC10	98L514WC10
19920	150	59L155WC10	-	98L155WC10	-	98L555WC10	-
21600	150	59L156WC10	-	98L156WC10	-	98L556WC10	-

Individual High Voltage Fuseless 3-Phase Capacitors

⚡ Three Phase Cantilever Mount Units

These three-phase capacitor units use the same technology as our single-phase units and when mounted directly to a pole offer a convenient single piece alternative to a multi-unit pole mount rack.

Three Phase Standard Ratings and Product Numbers (non-internally fused)

Voltage	BIL (kV)	300 kVAR		400 kVAR	
		3 - Bushing Grounded Wye	4 - Bushing Ungrounded Wye	3 - Bushing Grounded Wye	4 - Bushing Grounded Wye
4160/2400	95	59L603WC29	59L623WC29	98L603WC29	98L623WC29
12470/7200	95	59L611WC59	59L631WC59	98L611WC59	98L631WC59
13200/7620	95	59L612WC59	59L632WC59	98L612WC59	98L632WC59
13800/7960	95	59L613WC59	59L633WC59	98L613WC59	98L633WC59
14400/8320	95	59L614WC59	59L634WC59	98L614WC59	98L634WC59



High Voltage Capacitor & Equipment Fuse & Accessories

⚡ Manufacturing Operations Resulting in Higher Quality

Expulsion Fuse Selection Example

Capacitor Rating: 100 kVAR, 4800V

15 kV and below, capacitor orientation is upright

	Fuse Link	Expulsion Fuse Tube	Fuse Spring
Item	115A162000035	31F2807001	248A695400001

Expulsion Fuse

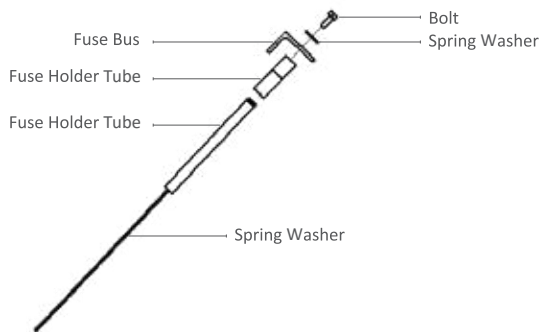

Vertical Mount Orientation



Edge (horizontal) Mount Orientation



Recommended fuse link ratings						
Unit Voltage	50 kVAR	100 kVAR	150 kVAR	200 kVAR	300 kVAR	400 kVAR
2400	25T	50K	80K	100K	-----	-----
2770	25T	40T	65K	80K	-----	-----
4160	20T	30T	40T	65K	80K	-----
4800	15T	25T	40T	50K	80K	100K
6640	12T	25T	30T	40T	50K	80K
7200	12T	25T	25T	30T	50K	80K
7620	10T	20T	25T	30T	50K	65K
7960	10T	20T	25T	30T	50K	65K
8320	10T	20T	25T	30T	40T	65K
9960	10T	15T	25T	25T	40T	50K
12470	10T	12T	20T	25T	30T	40T
13280	10T	12T	20T	25T	30T	40T
13800	10T	12T	15T	25T	25T	40T
14400	10T	12T	15T	25T	25T	30T
19920	8T	12T	15T	15T	25T	25T
21600	8T	12T	15T	15T	25T	25T

Expulsion Fuse Tube			
NOVO part	KV	Current	Interrupting
31F2807001	15	50	3600 amp. Sym
31F2808001	23	25	3600/1800 amp Sym
115A161500041	100	100	7400 amp Sym
115A161500049	50	50	1800 amp Sym

Fuse Springs	
NOVO Part	Capacitor Orientation
248A695400001	Upright
248A695400002	Edgemount

Fuse Links	
NOVO Part	EEL-NEMA rating
115A162000078	8T
115A162000079	10T
115A162000080	12T
115A162000063	15T
115A162000081	20T
115A162000035	25T
115A162000053	30T
115A162000036	40T
115A162000043	50K
115A162000024	65K
115A162000059	80K
115A162000025	100K

Bird Caps/Wildlife Protectors	
Item	GE Catalog
Capacitor Bird Caps with Sleeve	614A507000102

Capacitors & Equipment for High Voltage Surge

⚡ Application

NOVO Surge Capacitors and Motor Surge Protectors can be applied directly at the motor or generator terminals to reduce the potential for damage caused by lightning and or switching surges.

Surge Protective Capacitors reduce the steepness of wave fronts to protect turn to turn insulation from surges applied to or reflected within machine windings.

NOVO Motor surge Protectors utilize NOVO Surge Arresters applied in parallel with NOVO Surge Capacitors. When applied together, the arresters protect the major insulation to ground by limiting the amplitude of applied impulse waves or reflections within the machine windings, while the protective capacitor(s) reduce the steepness of the wave fronts. Studies indicate that this dual protection approach results in significant reduction of lightning stresses imposed on rotating machines and contribute to increased security against failures and downtime costs. The enclosure is suitable for indoor and outdoor applications.

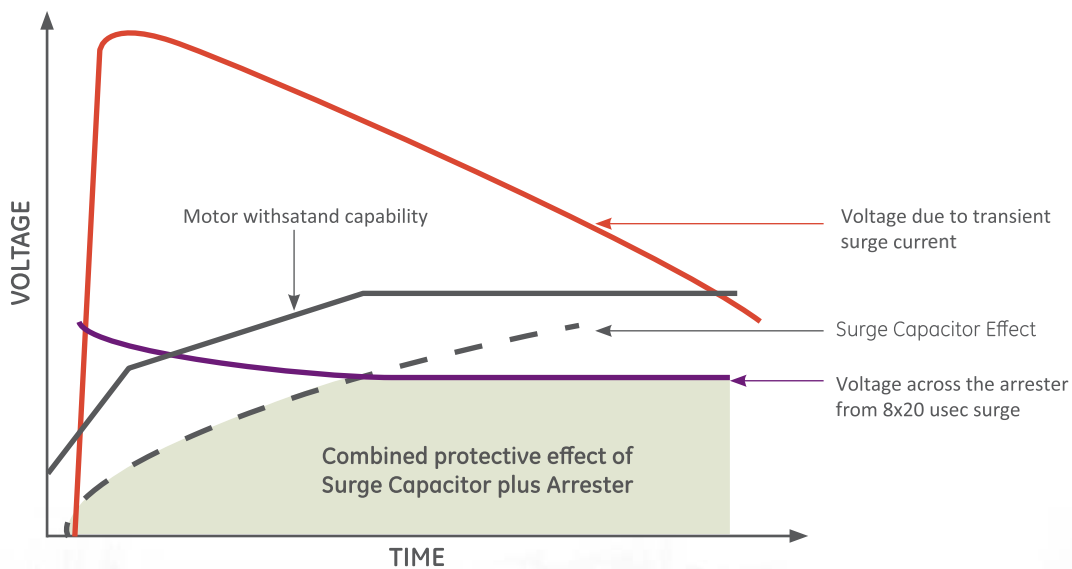

High Voltage Surge Capacitors & Equipment

Product Description, Features & Benefits

- Surge Protection for AC Generators, synchronous condensers and large motors
- Time proven NOVO dielectric system
- Dielektrol® Non-PCB insulating fluid
- Provides Turn-to-Turn insulation protection by reducing steepness of wave fronts applied to or reflected within the machine
- Used in combination with TRANQUELL ® NOVO station arresters for optimum protection
- Protective capacitors contain a film dielectric and hermetically sealed bushings, which permit mounting of the capacitors in an upright position or on their side1
- Altitude 0 to 150002

Note 1: Upside down mounting is allowed for 18L0060WH, 18L0061WH and 18L0062WH only. See product table for rating details.

Note 2: See Altitude De-rating table for de-rating of application voltage

Non-PCB Protective Capacitors with Internal Discharge Resistors -Indoor or Outdoor application

Voltage Rating rms Volts L-L *	Maximum Voltage rms Volts L-L	Catalog number	Poles per Unit	Microfarads per Pole	Approximate net weight		Drawing
					lbs	Kg	
0 - 650	715	9L18BBB301	3	1	4	18	A
2400	2640	18L0015WH	3	0.5	36	16.5	4
4160	4576	18L0015WH	3	0.5	36	16.5	4
6900	7590	18L0019WH	1	0.5	29	13	1
7200	7960	18L0065WH	3	0.5	35	16	5
13800	15180	18L0009WH	1	0.25	33	15	2
13800	15180	18L0012WH	3	0.25	66	30	6
24000	26400	18L0010WH	1	0.125	57	26	3
24940	-	18L0070WH	1	0.25	75	34	10
750 *	-	18L0004WH	1	4	12	5.5	9
3900 *	-	18L0005WH	1	4	46	20.9	8
13800	15180	18L0051WH	1	0.05	49	22.3	11
13800	15180	18L0060WH 1	1	0.25	32	14.5	6
6900	7590	18L0061WH 1	1	0.5	30	13.6	1
4160	4576	18L0062WH 1	3	0.5	36	16.4	4

* 18L0004WH and 18L0005WH are rated for DC Applications

1. Units are rated for inverted mounting
2. For other mounting arrangements contact factory.
3. 2400 and 4160 volt rated designs are identical and use the same catalog number
4. All AC capacitor units are CSA labeled

Protective Capacitor- Altitude De-Rating

⚡ Altitude De-rating of Capacitors above 3,300 ft (1000 m)

Altitude		Altitude Correction (1)
(ft)	(m)	
3,300	1000	1
4,000	1200	0.98
5,000	1500	0.95
6,000	1800	0.92
7,000	2100	0.89
8,000	2400	0.86
9,000	2700	0.83
10,000	3000	0.8
12,000	3600	0.75
14,000	4200	0.7
15,000	4500	0.67

⁽¹⁾ multiplier X rated voltage for reduced application voltage at the given altitude



High Voltage Surge Capacitors & Equipment

⚡ Tranquell® Motor Surge Protector Product Selection Process

Equipment Guide Selection Process

1. Determine the nominal system voltage and connection at the equipment being protected (Line-to Line, delta or wye, grounded or ungrounded).
2. Select product from the Selection Table (catalog number from columns 2 or 3, based upon line-to-line voltage in column 1)

Voltage Rating rms Volts (L-L)	Catalog Number for Delta & Ungrounded Neutral Systems	Catalog Number for Grounded Neutral Systems	Arrester Rating kV rms	Arrester MCOV kV rms	Capacitor Microfarads per Pole μ F	Dimension "D" (side view in inches) See drawing for detail	Weight lbs
2400	38F2401	—	3	2.55	0.5	23	300
4160	38F2402	—	6	5.1	0.5	23	300
—	—	38F2403	3	2.55	0.5	23	300
4800	38F2404	—	6	5.1	0.5	23	300
6900	38F2405	—	9	7.65	0.5	23	300
7200	38F2406	—	9	7.65	0.5	23	300
13200	38F2407	—	18	15.3	0.25	23	300
—	—	38F2408	10	8.4	0.25	23	300
13800	38F2409	—	18	15.3	0.25	23	300
—	—	38F2410	12	10.2	0.25	23	300
24000	38F2411	—	27	22	0.125	36	350
—	—	38F2412	21	17	0.125	36	350

Typical Protective Capacitor Drawing

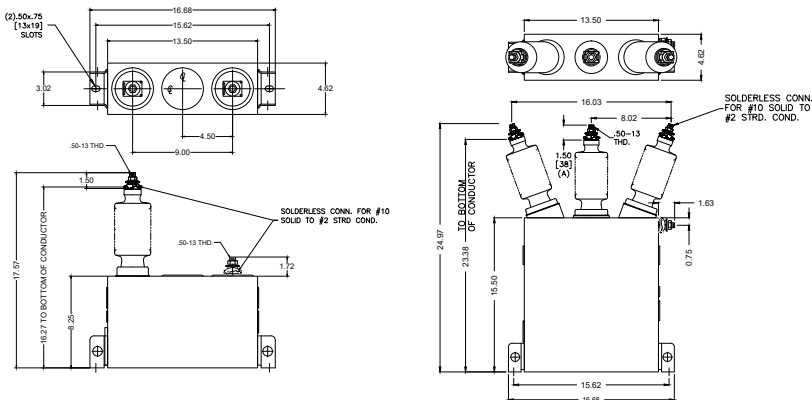

Typical Surge Equipment Drawing

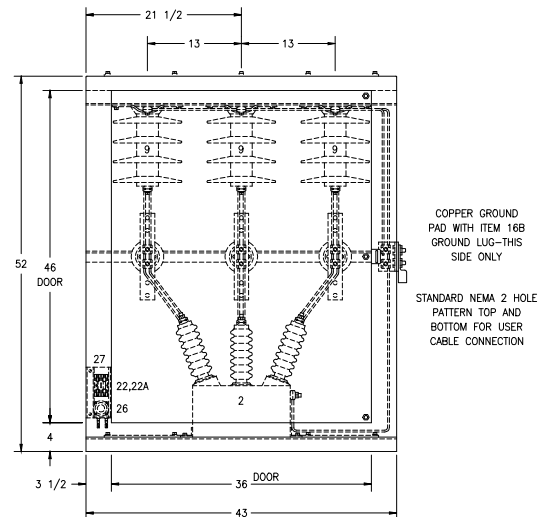

High Voltage Capacitor Equipment

⚡ Types and Benefits of High Voltage Capacitor Equipment and Harmonic Filters



Protective Capacitors & Equipment



Pole Top Shunt Banks



Open Rack Shunt Banks



Metal Enclosed Shunt or Filter Bank



Open Rack Harmonic Filter Bank



Series Compensation Bank

Use on Transmission System

- Released generation capacity
- Regulating of voltage levels
- Raised Voltage Levels

Use on Distribution System & Load

- Reduction of system losses
- Released System capacity
- Raise Voltage Levels

Distribution Pole Top Equipment

Applications

Used for voltage support or reducing system losses on distribution lines, less than 34.5kv

Voltage Range

2,400 to 34,500 Volts

Switched (oil or vacuum) or Fixed

Aluminum rack to accommodate 3,6,9,12 capacitors

Available optional accessories:

Current Potential Transformer Contoller Fuse cut outs Junction box Arresters



Distribution Pole Top Equipment

Options

- **Switches** - Oil or Vacuum. Usually single phase but available as 3 phase
- **Lightning Arresters** - Protection from Surges & Transients
- **Switching Controls** - Control switches based on sensing VARs, Voltage, Current, Time-of Day....etc.
- **Control Power Transformers (CPT's)** - 0.5 to 1.0 kVA. Supply 120V for control and/or motor/solenoid operation
- **Cutouts** - Mounted on the crossarm to take the bank off line in case of a short. Can also be used to manually trip bank.
- **Arrester/Cutout Combo**
- **Junction Box** - Weather resistant box metal or plastic where LV connections for switches/controls/CPT's are made.

Pole Mounted Capacitor Bank - Quotation Data Sheet

Total kVAR :	<input type="checkbox"/> (3600 kVAR Maximum)		
Line-to-Line System Voltage:			
Line to Neutral Voltage:			
System Connection:	<input type="checkbox"/> Grounded Wye <input type="checkbox"/> Ungrounded Wye <input type="checkbox"/> Delta		
BIL Rating:	<input type="checkbox"/> 95kV BIL <input type="checkbox"/> 125kV BIL <input type="checkbox"/> 150kV BIL		
Capacitor Configuration:	<input type="checkbox"/> kVAR per Capacitor <input type="checkbox"/> Capacitor Voltage Rating	<input type="checkbox"/> 2 Bushings Standard <input type="checkbox"/> 1 Bushing for 150kV BIL option for Grounded Wye	<input type="checkbox"/> 2 Bushings Standard
Switch BIL Rating:	<input type="checkbox"/> 95kV BIL <input type="checkbox"/> 110kV BIL	<input type="checkbox"/> 125kV BIL <input type="checkbox"/> 150kV BIL	
Switch Options:	<input type="checkbox"/> NO Switch <input type="checkbox"/> Motor Operated Oil Switch <input type="checkbox"/> Motor Operated Vacuum Switch		
Control Power Transformer Options:	<input type="checkbox"/> NO CPT <input type="checkbox"/> 0.5 kVA <input type="checkbox"/> 1.0kVA <input type="checkbox"/> 1.5kVA	<input type="checkbox"/> 2.0kVA <input type="checkbox"/> 2.5kVA <input type="checkbox"/> Other (Please Specify)	
Distribution Arresters:	<input type="checkbox"/> NO Arrester <input type="checkbox"/> 3 kV (2.55kV MCOV) <input type="checkbox"/> 6 kV (5.1kV MCOV) <input type="checkbox"/> 9 kV (7.65kV MCOV)	<input type="checkbox"/> 10kV (8.4kV MCOV) <input type="checkbox"/> 12kV (10.2kV MCOV) <input type="checkbox"/> 15kV (12.7kV MCOV) <input type="checkbox"/> 18kV (15.3kV MCOV)	<input type="checkbox"/> 21kV (17.0kV MCOV) <input type="checkbox"/> 24kV (19.5kV MCOV) <input type="checkbox"/> 27kV (22.0kV MCOV) <input type="checkbox"/> 30kV (24.4kV MCOV) <input type="checkbox"/> 36kV (29.0kV MCOV)
Meter Socket/J Box:	<input type="checkbox"/> NO Socket/Box <input type="checkbox"/> 4 Jaw + Junction Box and 30 Ft Cable <input type="checkbox"/> 6 Jaw + Junction Box and 30 Ft Cable <input type="checkbox"/> Junction Box Only		
Reactors:	<input type="checkbox"/> NO Junction Box <input type="checkbox"/> YES specify size		
Controller:	<input type="checkbox"/> NO Controller <input type="checkbox"/> Other controller options (please specify)		

Distribution Pole Top Equipment

The Pole Top Data Sheet is a representative guide of products offered by NOVO

NIC in most cases can offer specific product configuration, sizes and mounting as required by our customer.

Pole Top Product testing:

NIC 100% electrically tests all capacitors and control switch functions.

NIC leak tests all capacitors used in various equipment three times during the manufacturing process to assure one of the lowest leak rates in the industry.

Shunt Capacitor Bank Equipment

Applications

Provide VAR (reactive power) or voltage support and harmonic mitigation to transmission systems and distribution systems



Shunt Capacitor Bank Equipment

NOVO Product Offering

Typical Ratings:

- 2.4KVAR - 600MVAR, 12.47kV – 600kV
- Fusing schemes: Fuseless > 34.5 kV, Expulsion, Internally fused, Current Limiting Fuses
- Multiple switching and protection options available
- Seismic, Wind and High Altitude applications
- Provide power factor correction, voltage support & harmonic mitigation
- Shunt harmonic filter banks (Tuned shunt harmonic filter banks to 600 MVAR)

Shunt Capacitor Bank - Quotation Data Sheet

Total kVAR :	<input type="checkbox"/> 600 MVAR Maximum
Line-to-Line System Voltage:	
System Connection:	<input type="checkbox"/> Grounded Wye <input type="checkbox"/> Floating Wye <input type="checkbox"/> Delta <input type="checkbox"/> Double Wye
Fixed or switched bank	<input type="checkbox"/> Fixed <input type="checkbox"/> If switched indicate number of steps <input type="checkbox"/> kVAR per step
Substructure required (8 ft substructure is standard)	<input type="checkbox"/> No <input type="checkbox"/> Yes
Space limitations	<input type="checkbox"/> Yes (define) <input type="checkbox"/> No
Please specify required Options:	<input type="checkbox"/> CT <input type="checkbox"/> PT <input type="checkbox"/> Ground switch-phase <input type="checkbox"/> Ground switch-neutral <input type="checkbox"/> Ground switch- both <input type="checkbox"/> NO Ground switch
Harmonic Filter bank	<input type="checkbox"/> NO <input type="checkbox"/> Yes (Provide tuning point)

When optional apparatus is requested, please state the available short circuit current for proper sizing



Metal Enclosed Capacitor Bank Equipment

Metal Enclosed Capacitor Bank Equipment

Application

NOVO's Medium Voltage Metal Enclosed Capacitor and Harmonic Filter Banks are designed for industrial, commercial, and utility power systems requiring medium voltage automatic power factor correction. Standard designs are available for placement in outdoor or indoor substations (an enclosure integrity option can be added to allow for placement in publicly accessible areas) for power factor correction, loss reduction, and voltage support. The banks come fully assembled and ready for interconnection. Voltage range 2.4kV - 38kV.

NIC standard banks can be modified in most circumstances to meet your specific requirements. Contact NOVO to discuss your requirements and obtain a price quote.

NOVO can provide Power System Studies, Engineering Studies, System Design and Start-up/ Commissioning services.

See NOVO Publication NIC for complete details for NOVO Medium Voltage Metal Enclosed product offering details.

Series Capacitor Compensation Systems

Application

NIC Series Compensation System allows utilities to cost effectively increase power transfer capabilities of their existing infrastructure and new transmission lines.

Today's Transmission System Environment

Today's transmission system is becoming increasingly complex and is expected to carry bulk power in ways it was never designed for. The expectation is that transmission requirements will only increase, as power generation sources continue to evolve. Utilities around the globe are facing grid challenges such as:

- Reducing cost of new infrastructure projects and addressing changes in regulatory environments
- Meeting the rise in demand for efficient and reliable power
- Increasing electrification of rural areas and population growth of large cities
- Rapidly changing mix and location of various power generation types such as nuclear, hydro, wind and solar

Transmission utilities need to invest in new equipment, but also face increasing pressure to optimize the use of existing transmission assets to accommodate increased power transfer over longer distances.

The high voltage transmission lines are rarely limited by their thermal capacity (line sag). The transfer capabilities are more often set by voltage and stability limits, which are affected by circuit properties of the transmission systems that connect them.

To maximize the utilization of transmission assets it is necessary to adjust the circuit properties of the transmission system. The most cost-effective way to achieve this is by installing a comprehensive series compensation solution.

Strategically-placed series capacitors can often increase transmission transfer limits by a factor of two or three at a fraction of the cost of new transmission lines and can be deployed in 12 to 18 months.

- Newly patented TAG and Platform Dampening Technologies
- NOVO pioneered the use of SSR filter technology in a series capacitor system



Series Capacitor Compensation Systems

Best in Class Quality and Process Standards

- Industry leading and well established project management processes and procedures, certified to ISO® 9001 standards

NOVO's Solution

NIC Series Compensation System allows utilities to cost effectively increase power transfer capabilities of their existing infrastructure and new transmission lines. NOVO offers an extensive portfolio of project management skills, engineering capabilities, equipment, and installation services, delivering an integrated and robust system.

NIC scope of work can be tailored to match the project requirements and may vary from a simple Engineered Equipment Package (EEP) through an extensive Engineer, Procure, and Construct (EPC) project, often including work beyond the series compensation system.

Extensive Global and Unmatched Technical Experience

A worldwide leader in executing and delivering series compensation projects, in a broad range of utility environments resulting in reduced implementation risk.

- More than a century of experience designing transmission networks, including the first series compensation project in 1999
- Leading the industry by delivering over 10,000 Mvars of series compensation systems in the last three years
- Globally recognized as the foremost technical experts for power system projects since 1999

Industry Leading Patented Technology

Providing superior systems enabled by NOVO innovate products resulting in project cost savings and increased quality and reliability.

- Fastest Triggered Air Gap (TAG) available in the industry



NOVO HIGH VOLTAGE

NIC CAPACITOR AND EQUIPMENT

Guide to Product Selection and Application



NOVO
Electric technology UK Ltd

Email: info@ests.uk | Website: www.ests.uk | Mob: +44 7441 365495
Address: 71-75 Shelton Street Covent Garden, London, WC2H 9JQ, United Kingdom